



Exposed grid,  
demountable

OWAlifetime collection



## System S 3 | exposed grid, demountable

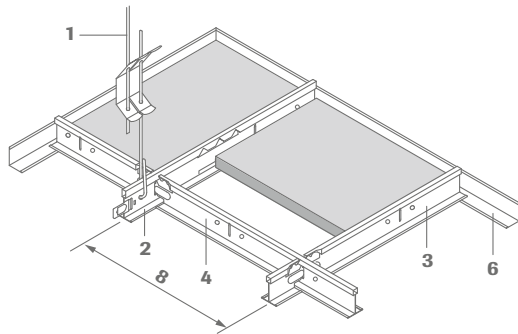

- 1 Hanger no. 12/.../...
- 2 Main tee no. 45, slots at 100 mm or 156.25 mm
- 3 Cross tee no. 46
- 4 Cross tee no. 47
- 5 Cross tee no. 48
- 6 Wall angle no. 50G
- 7 Shadow wall angle, for example no. 56
- 8 Module distance

### Section:

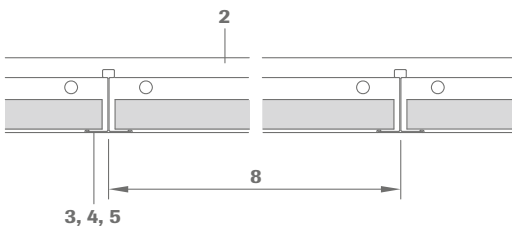

### Cross-section:

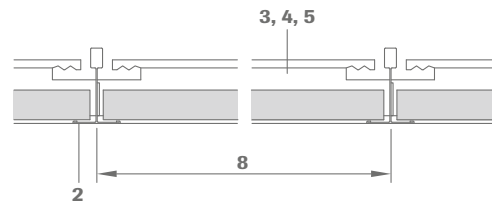

### Section dimensions:

No. 45

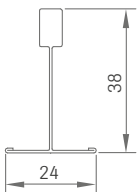

No. 46, 47, 48

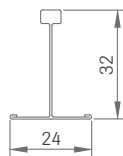

### Installation:

The cross tees have connection tabs on each end, 2 cross tee sections are inserted into each slot in the main tee section but care must be taken to insert the tabs correctly so that the tees are in correct alignment. The ends of the main tee sections have offset connectors which will lock when engaged.

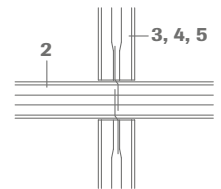

## Technical data | mineral tiles

### Dimensions/Designs

For possible dimensions and designs please refer to OWAlifetime collection price list 9001 e.

### Edge details

3

### Thickness

Approx. 12 mm, 15 mm and 20 mm (OWAcoustic premium)  
Approx. 14 mm (OWAcoustic smart)

### Reaction to fire

A2-s1,d0 in accordance with EN 13501-1

### Resistance to fire

See OWA-brochure 9501 eu e

### Metal suspensions

All metal components listed are galvanized steel. For further details and colours please consult OWAlifetime collection price list.

### Suspension depth

75 - 100 mm (depending on the existing structural ceiling) for ease of panel removal 120 mm is recommended

**Wall perimeter:**

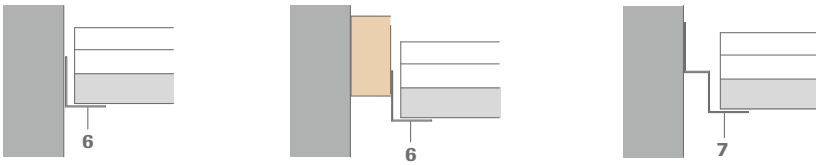

Other wall connection options and installation details can be found in OWA-Installation Guide 9801 e.

**Light fixtures:**

OWA provides appropriate lighting fixtures for this system.

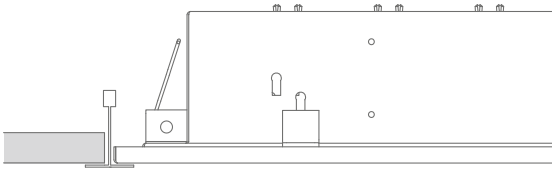

For details on installation and fire protection of lighting fixtures, see brochures 9630 e and OWA installation instructions 9801 e.

**Installation examples:**

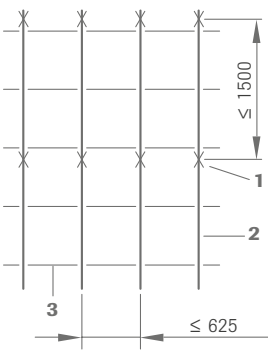

Module 625 x 625 mm

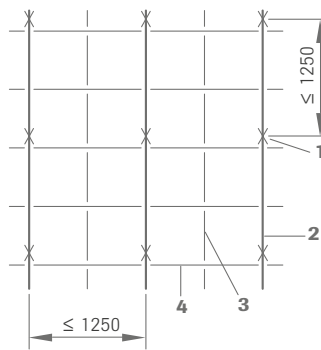

Module 625 x 625 mm

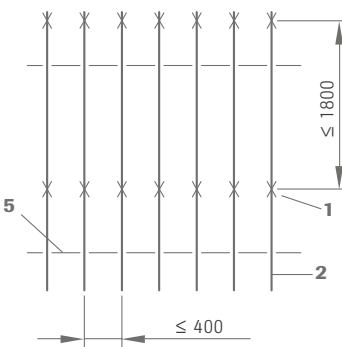

Module 2000 x 400 mm

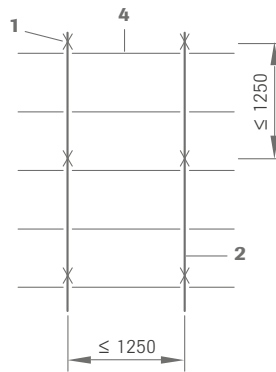

Module 1250 x 625 mm

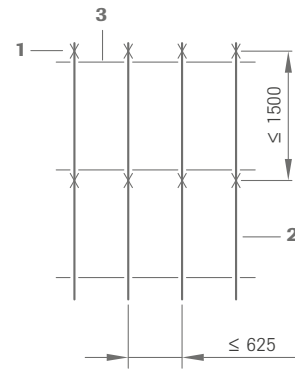

Module 1250 x 625 mm

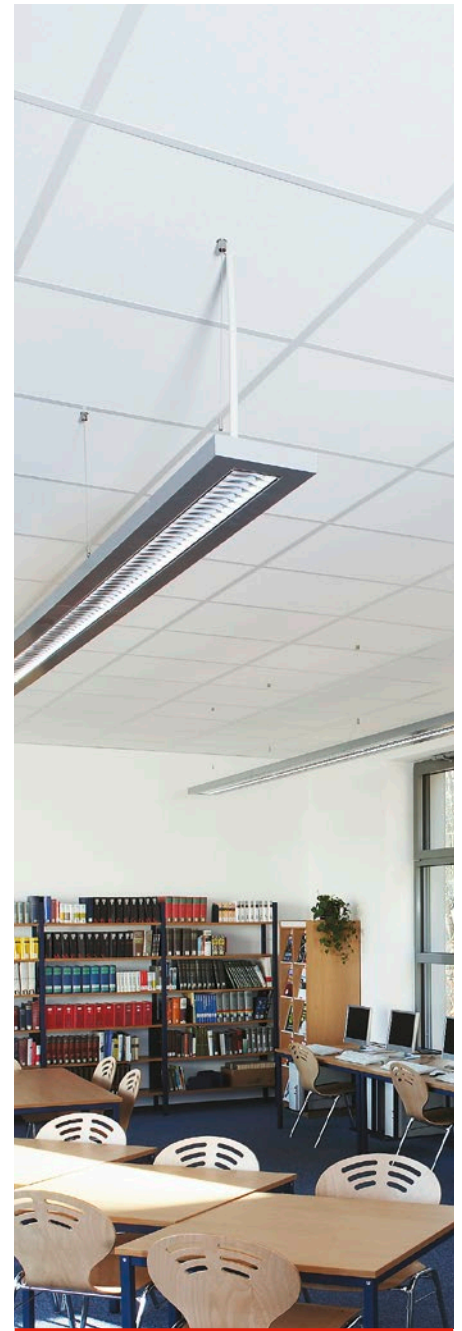

## Material requirements per m<sup>2</sup> (approximations):

Dimensions in mm

No.	Description	600 x 600	610 x 610	625 x 625	625 x 625*	1200 x 600	1220 x 610	1250 x 625	2000 x 400
12/.../...	Hanger	0.7 pce	0.7 pce	0.7 pce	1.1 pcs	0.7 pce	0.7 pce	0.7 pce	1.4 pcs
45	Main tee	0.83 m	0.82 m	0.8 m	1.6 m	0.83 m	0.82 m	0.8 m	2.5 m
46	Cross tee	0.83 m	0.82 m	0.8 m	1.6 m	-	-	-	-
47	Cross tee	1.66 m	1.64 m	1.6 m	-	1.66 m	1.64 m	1.6 m	-
48	Cross tee	-	-	-	-	-	-	-	0.5 m
50G	Wall angle	Depending on room size and shape							

\* Installed with main tee centres (≤ 625 mm)

## Weight per m<sup>2</sup>:

	600 x 600	610 x 610	625 x 625	625 x 625*	1200 x 600	1220 x 610	1250 x 625	2000 x 400
Suspension system approx.	1.25 kg/m <sup>2</sup>	1.223kg/m <sup>2</sup>	1.2 kg/m <sup>2</sup>	1.22 kg/m <sup>2</sup>	0.94 kg/m <sup>2</sup>	0.92 kg/m <sup>2</sup>	0.88 kg/m <sup>2</sup>	1.16 kg/m <sup>2</sup>
Tiles 15 mm approx.	4.5 kg/m <sup>2</sup>	4.5 kg/m <sup>2</sup>	4.5 kg/m <sup>2</sup>	4.5 kg/m <sup>2</sup>	4.5 kg/m <sup>2</sup>	4.5 kg/m <sup>2</sup>	4.5 kg/m <sup>2</sup>	4.5 kg/m <sup>2</sup>

For special situations, for example addition of wool overlays, light fixtures, cold roofs, high humidity and open areas etc., see OWA-Installation Guide 9801 e. For fire resistant ceilings, the distances between main tee profiles and suspension points must comply with the relevant test reports (see brochure 9501 eu e).

## System description:

### Exposed grid, demountable OWAconstruct System S 3 (lay-in)

#### Quality requirements for mineral tiles:

OWAcoustic mineral tiles firmly bound with a primer coat on both sides. The tile is free from asbestos. No formaldehyde is added in the manufacturing process of the mineral tiles. The mineral wool used for the manufacture of the tile is bio-soluble. The criteria for non-classification as a carcinogenic substance in accordance with the Chemicals Prohibition Ordinance (Section 1 Appendix, Paragraph 23 biopersistent fibres) are met and guaranteed by the 'RAL seal of approval for mineral wool'. Verification of fitness for use according to EU CPR: CE marking and Declaration of Performance (DoP).

**Installation** should be carried out in accordance with the information contained in system leaflet S 3 and OWA-Installation Guide 9801 e. All components are CE labelled.

#### Component list:

OWAconstruct hanger no. 12/.../2  
OWAconstruct main tee no. 45  
OWAconstruct cross tee no. 46, no. 47, no. 48  
OWAconstruct wall angle no. 50G

Mineral tiles accordance with EN 13964 and DIN 18177:

Air permeability class PM 1  
Formaldehyde class FH 1  
Emission of VOC TVOC 1

## Product warranties

The information provided in this leaflet is based on the standards and data available at the time of publication. Any performance, warranties or guarantees provided, expressed or implied, are subject to the exclusive use of OWA components and the installation of those components in accordance with our recommendations. Failure to adhere to these conditions will result in the invalidation of any performance claims, warranties or guarantees and rejection of any liability. OWA reserves the right to make any technical improvements to the products, systems or services without prior notice. **All goods and services are supplied in accordance with our current Terms and Conditions of Sale.** Errors excepted!



The information in this brochure is up-to-date at the time of publication. Errors and mistakes excepted. Please contact our competence team OWAconsult for specific advice. Our experts will be happy to answer your questions under the following contact details: tel: +49 9373 201-444 or e-mail: info@owaconsult.de

### Odenwald Faserplattenwerk GmbH

Dr.-F.-A.-Freundt-Straße 3 | 63916 Amorbach | Germany  
tel +49 9373 201-0 | info@owa.de  
www.owa-ceilings.com