



EXPOSED GRID, DEMOUNTABLE

OWAlifetime collection

OWA

System S 3 | exposed grid, demountable

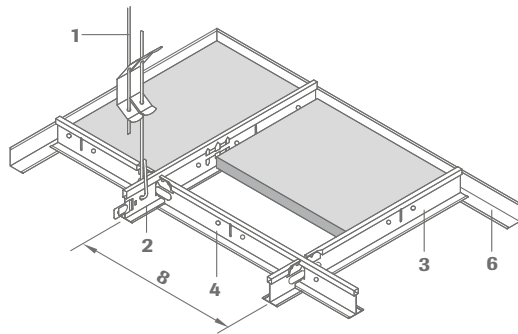

- 1 Hanger no. 12/.../...
- 2 Main tee no. 45, slots at 100 mm or 156.25 mm
- 3 Cross tee no. 46
- 4 Cross tee no. 47
- 5 Cross tee no. 48
- 6 Wall angle no. 50G
- 7 Shadow wall angle, for example no. 56
- 8 Module distance

Section:

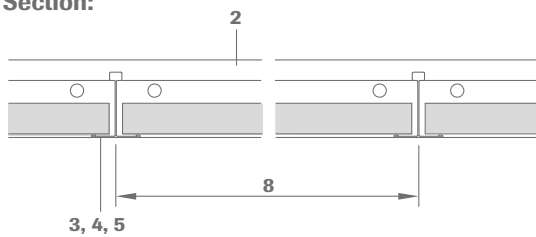

Cross-section:

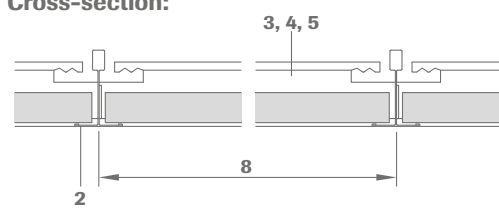

Section dimensions:

No. 45

No. 46, 47, 48

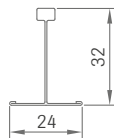
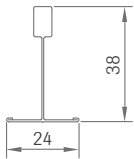

Installation:

The cross tees have connection tabs on each end, 2 cross tee sections are inserted into each slot in the main tee section but care must be taken to insert the tabs correctly so that the tees are in correct alignment. The ends of the main tee sections have offset connectors which will lock when engaged.

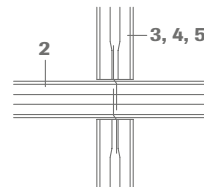

Technical data | mineral tiles

Dimensions

600 x 600 mm, 610 x 610 mm, 625 x 625 mm, 1200 x 600 mm, 1220 x 610 mm, 1250 x 625 mm
width: 300 mm, 312.5 mm, 400 mm | length: 1200 mm, 1250 mm, 2000 mm*, 2500 mm*

Other sizes available on request. Subject to minimum quantities and surcharges. See OWAlifetime collection price list.
* only conditionally demountable

Edge details

3

Thickness

Approx. 15 mm and 20 mm (OWAcoustic® premium)

Also suitable for OWAcoustic smart and OWAdeco (technical data on request)

Reaction to fire

A2-s1,d0 in accordance with EN 13501-1

Resistance to fire

See OWA-brochure no. 9500 eu e

Metal suspensions

All metal components listed are galvanized steel. For further details and colours please consult OWAlifetime collection price list.

Suspension depth

75 - 100 mm (depending on the existing structural ceiling) for ease of panel removal 120 mm is recommended

Wall perimeter:

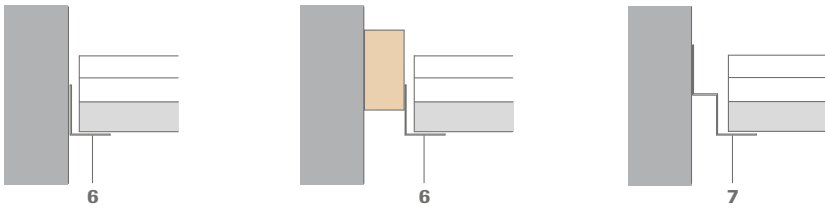

Other wall connection options and installation details can be found in OWA-Installation Guide no. 801 E.

Light fixtures:

Compatible light fixtures please see OWA-brochure no. 9630 e and OWA-Installation Guide no. 801 E.

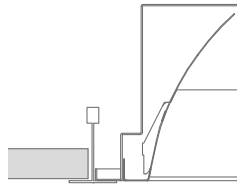

Installation examples:

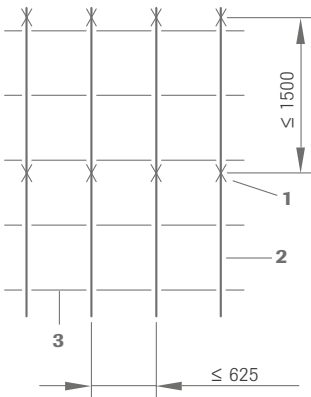

Module 625 x 625 mm

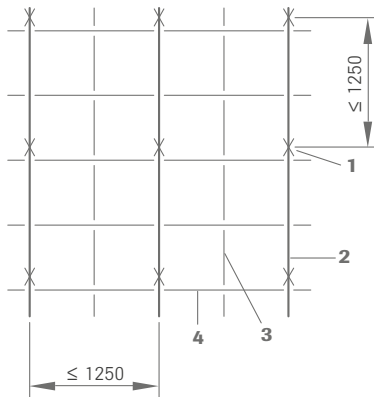

Module 625 x 625 mm

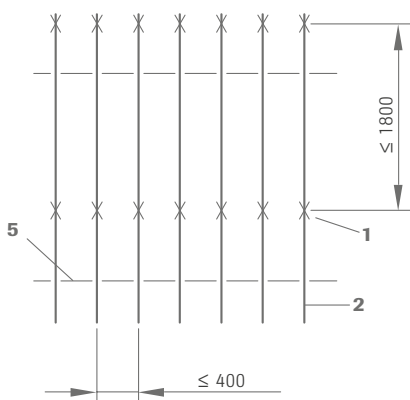

Module 2000 x 400 mm

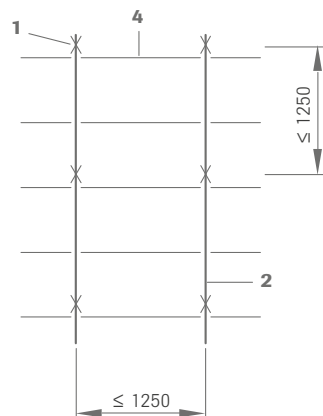

Module 1250 x 625 mm

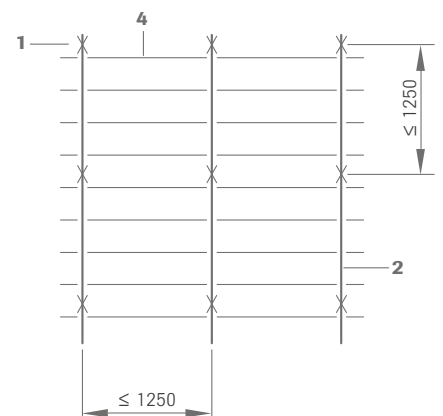

Module 1250 x 312.5 mm



Material requirements per m² (approximations)²

Dimensions in mm

No.	Description	600 x 600	610 x 610	625 x 625	625 x 625*	1200 x 300	1200 x 600	1220 x 610	1250 x 312.5	1250 x 625	2000 x 400
12/.../...	Hanger	0.7 pce	0.7 pce	0.7 pce	1.1 pcs	0.7 pce	0.7 pce	0.7 pce	0.7 pce	0.7 pce	1.4 pcs
45	Main tee	0.83 m	0.82 m	0.8 m	1.6 m	0.83 m	0.83 m	0.82 m	0.8 m	0.8 m	2.5 m
46	Cross tee	0.83 m	0.82 m	0.8 m	1.6 m	-	-	-	-	-	-
47	Cross tee	1.66 m	1.64 m	1.6 m	-	3.33 m	1.66 m	1.64 m	3.2 m	1.6 m	-
48	Cross tee	-	-	-	-	-	-	-	-	-	0.5 m
50G	Wall angle	depending on room size and shape									

* installed with main tee centres (≤ 625 mm)

Weight per m²:

	600 x 600	610 x 610	625 x 625	625 x 625*	1200 x 300	1200 x 600	1220 x 610	1250 x 312.5	1250 x 625	2000 x 400
Suspension system approx.	1.25 kg/m ²	1.223kg/m ²	1.2 kg/m ²	1.22 kg/m ²	1.54 kg/m ²	0.94 kg/m ²	0.92 kg/m ²	1.48 kg/m ²	0.88 kg/m ²	1.16 kg/m ²
Tiles 15 mm approx.	4.5 kg/m ²	4.5 kg/m ²	4.5 kg/m ²	4.5 kg/m ²	4.5 kg/m ²	4.5 kg/m ²	4.5 kg/m ²	4.5 kg/m ²	4.5 kg/m ²	4.5 kg/m ²

For special situations, for example addition of wool overlays, light fixtures, cold roofs, high humidity and open areas etc., see OWA-Installation Guide no. 801 E. For fire resistant ceilings, the distances between main tee profiles and suspension points must comply with the relevant test reports (see brochure no. 9500 eu e).

System description:

Exposed grid, demountable OWAconstruct® System S 3 (lay-in)

Quality statement:

OWAacoustic mineral panels are free from harmful materials such as asbestos and formaldehyde. A statement from the German institute for Building Technology is available. The mineral wool used in these panels is biodegradable. The criteria of the zero-ranking as a carcinogenic material in the chemical prohibition ordinance (§ 1 appendix) section 23 bio-persistent fibres are complied with and therefore carries the "RAL-Seal of mineral wool" guarantees.

Mineral tiles according to EN 13964 and DIN 18177:

Air Permeability Class PM 1
Formaldehyde FH Class 1
TVOC Class 1

Installation should be carried out in accordance with the information contained in system leaflet S 3 and OWA-Installation Guide no. 801 E. All components are CE labelled.

Component list:

OWAconstruct hanger no. 12/.../2
OWAconstruct main tee no. 45
OWAconstruct cross tee no. 46, no. 47, no. 48
OWAconstruct wall angle no. 50G

Product Warranties

The information provided in this leaflet is based on the standards and data available at the time of publication. Any performance, warranties or guarantees provided, expressed or implied, are subject to the exclusive use of OWA components and the installation of those components in accordance with our recommendations. Failure to adhere to these conditions will result in the invalidation of any performance claims, warranties or guarantees and rejection of any liability. OWA reserves the right to make any technical improvements to the products, systems or services without prior notice. **All goods and services are supplied in accordance with our current Terms and Conditions of Sale.** Errors excepted!



Odenwald Faserplattenwerk GmbH

Dr.-F.-A.-Freundt-Straße 3 | 63916 Amorbach
tel +49 93 73.2 01-0 | info@owa.de
www.owa-ceilings.com