



Exposed grid,  
demountable

OWAlifetime collection

**OWA**

## System S 15a cliq | Exposed grid, demountable

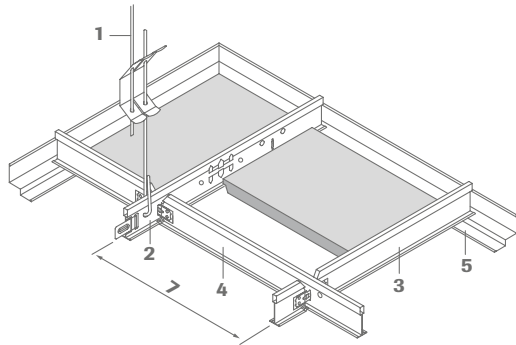

- 1 Hanger no. 12/.../...
- 2 Main tee cliq-24-MR, slots at 100, 152.5 or 156.25 mm centres
- 3 Cross tee cliq-15-CT short
- 4 Cross tee cliq-15-CT long
- 5 Shadow wall angle no. 50/15G
- 6 Contura block no. 42/15
- 7 Module distance

**Section dimensions:**  
cliq-15-MR,  
cliq-15-CT

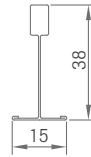

**Section:**

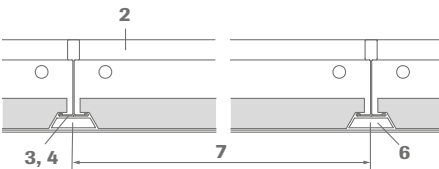

**Cross-section:**

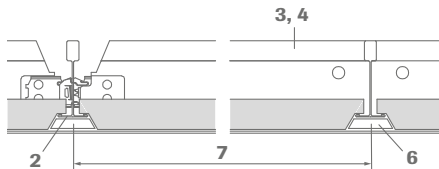

**Construction:**

Cross tees are fitted with connection tabs at each end that are inserted into the corresponding vertical slots in the stalk of the main tee. As the tabs are „handed“ care must be taken to ensure each cross tee is inserted into the correct side of the slot (see diagram). Main tees are joined together using the integral locking, offset, end connectors.

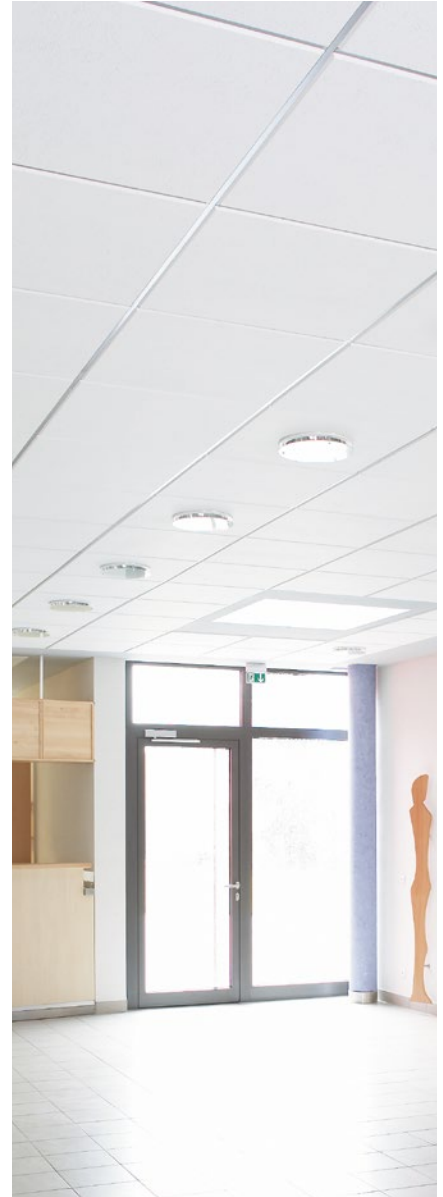
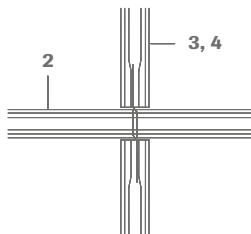

## Technical data | Mineral tiles

### Dimensions

600 x 600 mm, 610 x 610 mm, 625 x 625 mm, 1200 x 600 mm, 1220 x 610 mm, 1250 x 625 mm  
widths: 300 mm, 305 mm, 312.5 mm, 400 mm

lengths: 1200 mm, 1220 mm, 1250 mm, 2000\* mm, 2500\* mm

Other sizes available on request. Subject to minimum quantities and surcharges. See OWAlifetime collection price list.

\* Only conditionally demountable

### Edge details

15

### Thickness

Approx. 15 mm and 20 mm (OWAcoustic premium)

### Reaction to fire

A2-s1,d0 in accordance with EN 13501-1

### Resistance to fire

REI 90 (90 minutes) in accordance with EN 13501-2  
test reports are available on request

### Metal suspensions

All profiles are galvanised and visible surfaces painted white. For further details and colours please consult OWAlifetime collection price list.

### Suspension depth

Minimum suspension depth 75 - 100 mm (from underside of soffit). For ease of panel removal 120 mm is recommended

### Wall perimeter:

When using shadow edge wall perimeter no. 50/15G, the gaps between the tee sections and the lower flange of the wall perimeter can be filled with Contura infill blocks no. 42/15. For further examples of wall perimeter and installation details see OWA-Installation Guide no. 9801 e.

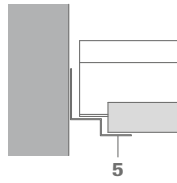

### Installation examples:

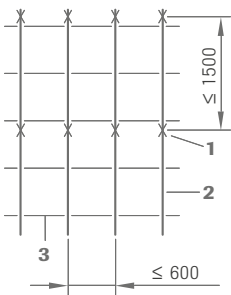

Module 600 x 600 mm

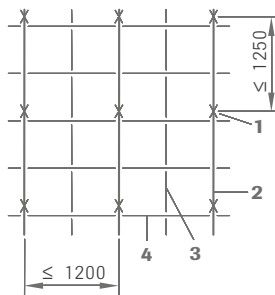

Module 600 x 600 mm

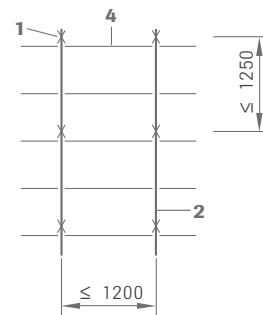

Module 1200 x 600 mm

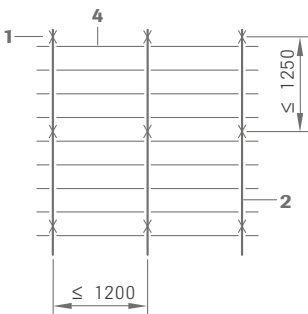

Module 1200 x 300 mm

### Light fixtures:

OWA can supply compatible light fixtures for this system.

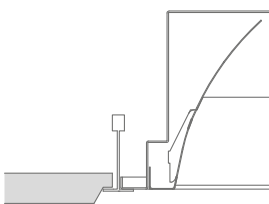

For details of performance, installation and fire resistance please see OWA-brochure no. 9630 e and OWA-Installation Guide no. 9801 e.

**Material requirements per m<sup>2</sup>** (approximations):  
dimensions in mm

No.	Description	600 x 600	610 x 610	625 x 625	1200 x 600	1220 x 610	1250 x 625	1200 x 300	1250 x 312.5
12/.../...	Hanger	0.7 pce	0.7 pce	0.7 pce	0.7 pce	0.7 pce	0.7 pce	0.7 pce	0.7 pce
cliq-15-MR	Main tee	0.83 lm	0.82 lm	0.8 lm	0.83 lm	0.82 lm	0.8 lm	0.83 lm	0.8 lm
cliq-15-CT	Short cross tee	0.83 lm	0.82 lm	0.8 lm	-	-	-	-	-
cliq-15-CT	Long cross tee	1.66 lm	1.64 lm	1.6 lm	1.66 lm	1.64 lm	1.6 lm	3.33 lm	3.2 lm
42/15	Contura infill block	Dependent on room shape, size and ceiling module							
50/15G	Shadow perimeter trim	Dependent on room size and shape							

**Weight per m<sup>2</sup>:**

	600 x 600	610 x 610	625 x 625	1200 x 600	1220 x 610	1250 x 625	1200 x 300	1250 x 312.5
Suspension system approx.	1.06 kg/m <sup>2</sup>	1.05 kg/m <sup>2</sup>	1.03 kg/m <sup>2</sup>	0.81 kg/m <sup>2</sup>	0.83 kg/m <sup>2</sup>	0.78 kg/m <sup>2</sup>	1.32 kg/m <sup>2</sup>	1.27 kg/m <sup>2</sup>
Tiles 15 mm approx.	4.5 kg/m <sup>2</sup>	4.5 kg/m <sup>2</sup>	4.5 kg/m <sup>2</sup>	4.5 kg/m <sup>2</sup>	4.5 kg/m <sup>2</sup>	4.5 kg/m <sup>2</sup>	4.5 kg/m <sup>2</sup>	4.5 kg/m <sup>2</sup>

For special situations, for example addition of wool overlays, light fittings, cold roofs, high humidity and open areas etc., see OWA Installation Guide no. 9801 e. For fire resistant ceilings, the distances between main tee profiles and suspension points must comply with the relevant test reports (see brochure no. 9500 eu e).

**System description:**

**OWAacoustic system S 15a cliq – exposed metal grid system**

**Quality requirements for mineral tiles:**

OWAacoustic mineral tiles firmly bound with a primer coat on both sides. The tile is free from asbestos. No formaldehyde is added in the manufacturing process of the mineral tiles. The mineral wool used for the manufacture of the tile is bio-soluble. The criteria for non-classification as a carcinogenic substance in accordance with the Chemicals Prohibition Ordinance (Section 1 Appendix, Paragraph 23 biopersistent fibres) are met and guaranteed by the „RAL seal of approval for mineral wool“. Verification of fitness for use according to EU CPR: CE marking and Declaration of Performance (DoP).

Mineral tiles accordance with EN 13964 and DIN 18177:

Air permeability class	PM 1
Formaldehyde class	FH 1
Emission of VOC	TVOC 1

**Installation** should be carried out in accordance with the information contained in system leaflet S 15a cliq and OWA-Installation Guide no. 9801 e. All components are CE labelled.

**Component list:**

- OWAconstruct hanger no. 12/.../2
- OWAconstruct main tee cliq-15-MR
- OWAconstruct cross tees cliq-15-CT long and short
- OWAconstruct shadow wall angle no. 50/15G
- OWAconstruct contura block no. 42/15

**Product Warranties**

The information provided in this leaflet is based on the standards and data available at the time of publication. Any performance, warranties or guarantees provided, expressed or implied, are subject to the exclusive use of OWA components and the installation of those components in accordance with our recommendations. Failure to adhere to these conditions will result in the invalidation of any performance claims, warranties or guarantees and rejection of any liability. OWA reserves the right to make any technical improvements to the products, systems or services without prior notice. **All goods and services are supplied in accordance with our current Terms and Conditions of Sale.** Errors excepted!



The information in this brochure is up-to-date at the time of publication. Errors and mistakes excepted. Please contact our competence team OWAconsult for specific advice. Our experts will be happy to answer your questions under the following contact details: tel: +49 93 73. 2 01-4 44 or e-mail: info@owaconsult.de

**Odenwald Faserplattenwerk GmbH**  
Dr.-F.-A.-Freundt-Straße 3 | 63916 Amorbach  
tel +49 93 73. 2 01-0 | info@owa.de  
www.owa-ceilings.com