



Exposed grid, demountable
increased corrosion protection

OWAlifetime collection

OWA

System S 3e | exposed grid, demountable

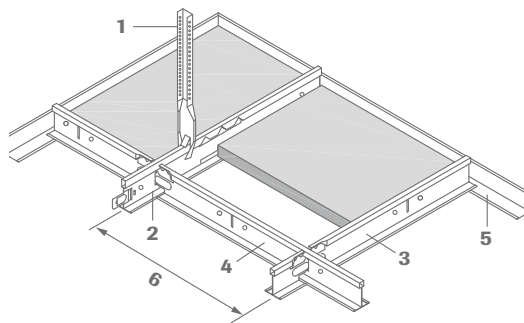

- 1 Hanger no. 17/45KB
- 2 Main tee no. 45KB
- 3 Cross tee no. 46KB
- 4 Cross tee no. 47KB
- 5 Wall angle no. 50KB
- 6 Module size

Note: This system is only available from OWA-Amorbach

Section:

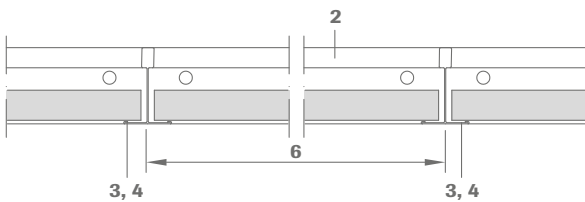

Cross-Section:

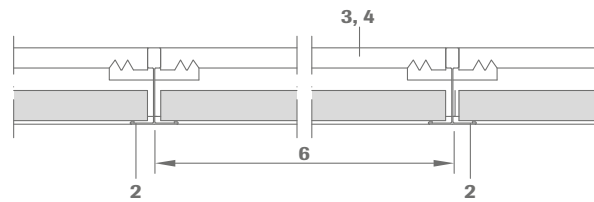

Section dimension:

No. 45KB, no. 46KB
and no. 47KB

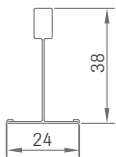

Installation:

The cross tees have connection tabs on each end, 2 cross tee sections are inserted into each slot in the main tee section but care must be taken to insert the tabs correctly so that the tees are in correct alignment. The ends of the main tee sections have offset connectors which will lock when engaged.

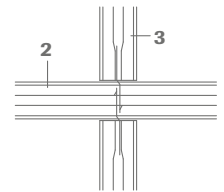

Technical data | mineral tiles

Dimensions/Designs

For possible dimensions and designs, please refer to the [OWAlifetime collection price list 9001 e.](#)

Edge details

3

Designs

Mavroc® Constellation, Ocean, Humancare Plus, Humancare Pro and Humancare Lab

Thickness

Approx. 15 mm and approx. 20 mm

Reaction to fire

OWAacoustic premium tile: A2-s1,d0 in accordance with EN 13501-1
OWAconstruct suspension parts: A1 in accordance with EN 13501-1

Metal suspensions

All metal parts protected against corrosion with 275 g zinc/m²/side and given an additional 25 µm coating on both sides

Suspension depth

75 - 100 mm (depending on the existing structural ceiling) for ease of panel removal 120 mm is recommended

Corrosion protection

Class D in accordance with EN 13964 for use in indoor swimming pools.
(For more informations please contact: anfragen_consult@owa.de)

Resistance to fire

On request

Wall perimeter:



Other wall connection options and installation details can be found in [OWA-Installation Guide 9801 e](#).

Light fixtures:

OWA can supply compatible light fixtures for this system.

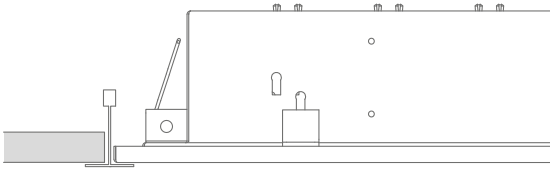

For details of performance, installation and fire resistance please see [OWA-brochure 9630 e](#) and [OWA-Installation Guide 9801 e](#).

Installation examples:

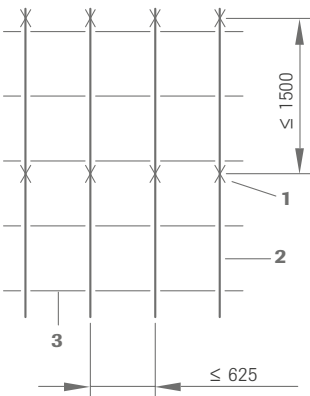

Module 625 x 625 mm

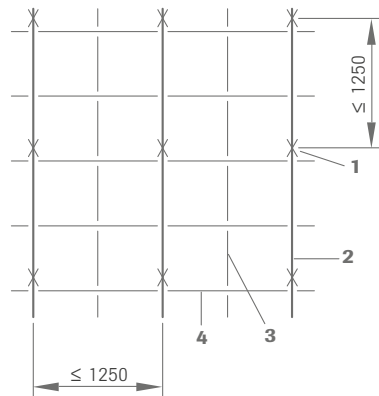

Module 625 x 625 mm

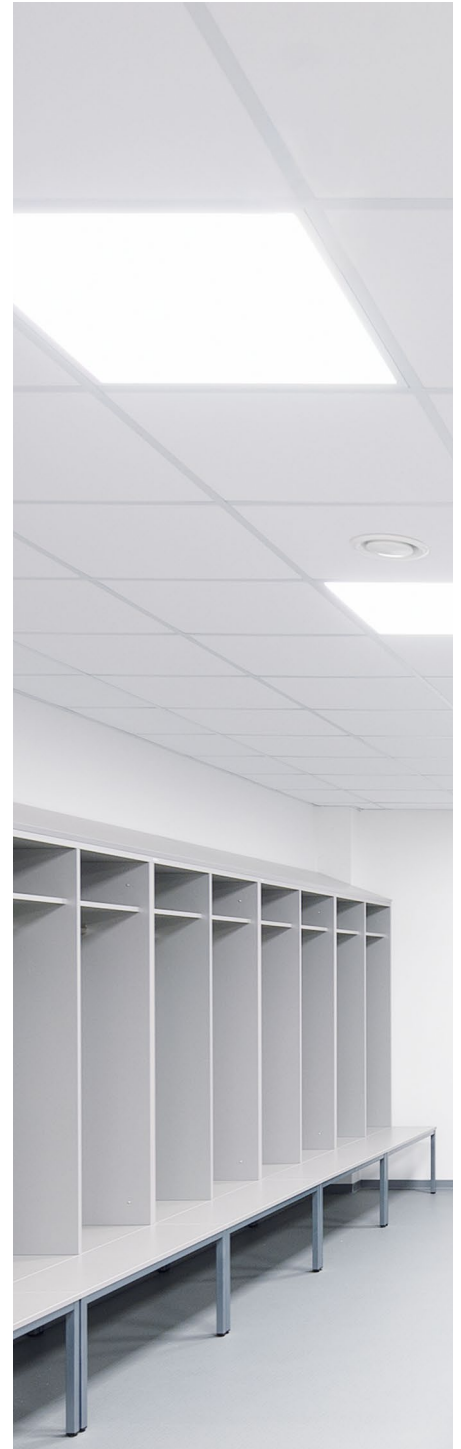

Attention:

Additional measures must be followed for use in indoor swimming pools and wet rooms. Request our information sheet and contact our consulting department OWAconsult, or alternatively follow [OWA-Installation Guide 9801 e](#).

When installing suspended ceilings in rooms according to class D, all construction interfaces must be retreated with Zincor or a commercial aluminium-zinc spray to prevent corrosion (also see section 4.3.1 of [OWA-Installation Guide 9801 e](#)).

Material requirements per m² (approximations)

Dimensions in mm

No.	Description	600 x 600	625 x 625
17/45KB	Hanger	0.7 pce	0.7 pce
45KB	Main tee	0.83 m	0.8 m
46KB	Cross tee	0.83 m	0.8 m
47KB	Cross tee	1.66 m	1.6 m
50KB	Wall angle	Depending on room size and shape	

Weight per m²:

	600 x 600	625 x 625
Suspension system approx.	1.25 kg/m ²	1.2 kg/m ²
Tiles 15 mm approx.	4.5 kg/m ²	4.5 kg/m ²

For special situations, for example addition of wool overlays, light fixtures, cold roofs, high humidity and open areas etc., see [OWA-Installation Guide 9801 e](#). For fire resistant ceilings, the distances between main tee profiles and suspension points must comply with the relevant test reports (see [OWA brochure 9501 eu e](#)).

System description:

Exposed grid, demountable OWAconstruct System S 3e (corrosion protection)

Quality requirements for mineral tiles:

OWAcoustic mineral tiles firmly bound with a primer coat on both sides. The tile is free from asbestos. No formaldehyde is added in the manufacturing process of the mineral tiles. The mineral wool used for the manufacture of the tile is bio-soluble. The criteria for non-classification as a carcinogenic substance in accordance with the Chemicals Prohibition Ordinance (Section 1 Appendix, Paragraph 23 biopersistent fibres) are met and guaranteed by the 'RAL seal of approval for mineral wool'. Verification of fitness for use according to EU CPR: CE marking and Declaration of Performance (DoP).

Installation should be carried out in accordance with the information contained in system leaflet S 3e and [OWA-Installation Guide 9801 e](#). All components are CE labelled.

Component list:

OWAconstruct hanger no. 17/45KB
OWAconstruct main tee no. 45KB
OWAconstruct cross tee no. 46KB, no. 47KB
OWAconstruct wall angle no. 50KB

Mineral tiles accordance with EN 13964 and DIN 18177:

Air permeability class PM 1
Formaldehyde class FH 1
Emission of VOC TVOC 1



Certified Management Systems

Product warranties

The information provided in this leaflet is based on the standards and data available at the time of publication. Any performance, warranties or guarantees provided, expressed or implied, are subject to the exclusive use of OWA components and the installation of those components in accordance with our recommendations. Failure to adhere to these conditions will result in the invalidation of any performance claims, warranties or guarantees and rejection of any liability. OWA reserves the right to make any technical improvements to the products, systems or services without prior notice. **All goods and services are supplied in accordance with our current Terms and Conditions of Sale.** Errors excepted!



The information in this brochure is up-to-date at the time of publication. Subject to alterations. Please contact our OWAconsult team for specific advice. Our experts will be happy to answer your questions using the following contact details: tel: +49 9373 201-444 or e-mail: info@owaconsult.de

Odenwald Faserplattenwerk GmbH

Dr.-F.-A.-Freundt-Straße 3 | 63916 Amorbach | Germany
tel +49 9373 201-0 | info@owa.de
www.owa-ceilings.com